



ARM Cortex[®]-M4 32-BIT MICROCONTROLLER

NuTiny-SDK-M453 User Manual for NuMicro[™] M453 Series

The information described in this document is the exclusive intellectual property of Nuvoton Technology Corporation and shall not be reproduced without permission from Nuvoton.

Nuvoton is providing this document only for reference purposes of NuMicro[™] microcontroller based system design. Nuvoton assumes no responsibility for errors or omissions.

All data and specifications are subject to change without notice.

For additional information or questions, please contact: Nuvoton Technology Corporation.



Table of Contents

1	Overview	3
2	Introduction to NuTiny-SDK-M453	3
2.1	NuTiny-SDK-M453 System Description	4
2.2	Pin Assignment for Extended Connectors	6
2.3	NuTiny-SDK-M453 PCB Placement	9
3	Starting to Use NuTiny-SDK-M453 on the Keil μ Vision [®] IDE	10
3.1	Downloading and Installing Keil μ Vision [®] IDE Software	10
3.2	Downloading and Installing Nuvoton Nu-Link Driver	10
3.3	Hardware Setup.....	10
3.4	Example Program.....	11
4	Starting to Use NuTiny-SDK-M453 on the IAR Embedded Workbench	12
4.1	Downloading and Installing IAR Embedded Workbench Software.....	12
4.2	Downloading and Installing Nuvoton Nu-Link Driver	12
4.3	Hardware Setup.....	12
4.4	Example Program.....	13
5	NuTiny-SDK-M453 Schematics	14
5.1	NuTiny-EVB-M453 Schematic	14
5.2	Nu-Link-Me Schematic.....	18
6	Downloading NuMicro [™] Related Files from Nuvoton Website	19
6.1	Downloading NuMicro [™] Keil μ Vision [®] IDE Driver	19
6.2	Downloading NuMicro [™] IAR EWARM Driver	21
6.3	Downloading NuMicro [™] M453 Series BSP Software Library.....	23
7	Revision History	24

1 Overview

The NuTiny-SDK-M453 is a specific development tool for NuMicro™ M453 Series. User can use NuTiny-SDK-M453 to develop and verify the application program easily. The NuTiny-SDK-M453 includes two parts: NuTiny-EVB-M453 and Nu-Link-Me. The NuTiny-EVB-M453 is the evaluation board and Nu-Link-Me is its Debug Adaptor. Therefore, user does not need other additional ICE or debug equipment.

2 Introduction to NuTiny-SDK-M453

The NuTiny-SDK-M453 uses the M453VG6AE as the target microcontroller. Figure 2-1 shows the NuTiny-SDK-M453 for M453 Series, in which the left portion is called NuTiny-EVB-M453 and the right portion is called Nu-Link-Me.

The NuTiny-EVB-M453 is similar to other development boards. User can use it to develop and verify applications to emulate the real behavior. The on-board chip covers M453 Series features. The NuTiny-EVB-M453 can be a real system controller to design users' target systems.

The Nu-Link-Me is a Debug Adaptor, which connects your PC's USB port to your target system (via Serial Wired Debug port) and allows you to program and debug embedded programs on the target hardware. To use the Nu-Link-Me Debug Adaptor with IAR or Keil, please refer to the "Nuvoton NuMicro™ IAR ICE Driver User Manual" or "Nuvoton NuMicro™ Keil ICE Driver User Manual" for details. The two documents will be stored in the local hard disk when each driver is installed.

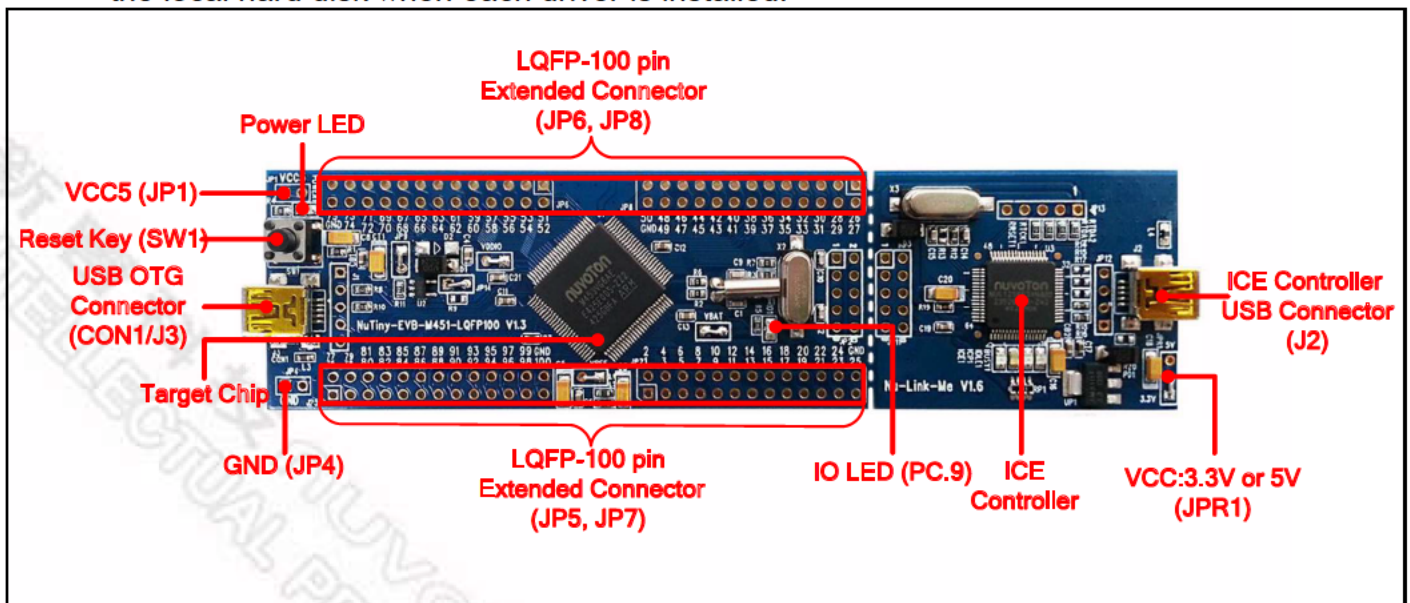

Figure 2-1 NuTiny-SDK-M453 (Blue PCB Board)

2.1 NuTiny-SDK-M453 System Description

2.1.1 Power Settings

- **J2**: USB port in Nu-Link-Me
- **CON1/J3**: Micro USB port in NuTiny-EVB-M453
- **JP1**: VCC5V voltage connector in NuTiny-EVB-M453

POWER Mode	J2 USB Port (Mini)	CON1/J3 USB Port (Mini/Micro)	JP1 VCC5V	MCU Voltage	Comment
Mode 1	Connected to PC	X	DC 3.3V or 5V Output	DC 3.3V or 5 V	J2 (from PC) supplies the power. MCU voltage can be selected to 3.3V or 5V through JPR1.
Mode 2	X	Connect to PC (USB port is device)	DC 3.3V or 5V Output	DC 3.3 V or 5V	CON1/J3 (from PC) supplies the power when pins of JP14 are shorted together.
Mode 3	X	Connect to USB device (USB port is host)	DC 5V Input	DC 5V	JP1 supplies the power when JP1 is wired to pin1 of JP14 .

X: Unused.

2.1.2 Debug Connectors

- **JP2**: The connector in the target board (NuTiny-EVB-M453) for connecting with Nuvoton ICE adaptor (Nu-Link, Nu-Link-Pro or Nu-Link-Me)
- **JP11**: The connector in the ICE adaptor (Nu-Link-Me) for connecting with a target board (e.g. NuTiny-EVB-M453)

2.1.3 USB Connector

- **J2**: Mini USB connector in Nu-Link-Me connected to a PC USB port

2.1.4 USB OTG Host/Device Connector

- **CON1/J3**: Mini/Micro USB connector in NuTiny-EVB-M453 for application use

2.1.5 Extended Connectors

- **JP5, JP6, JP7 and JP8**: Show all chip pins in NuTiny-EVB-M453

2.1.6 Reset Buttons

- **SW1**: Reset button in NuTiny-EVB-M453. Press this key to reset the target chip M453VG6AE.

2.1.7 Power Connectors

- **JPR1:** An option to select whether the 3.3V voltage input supplied by the ICE bridge (default)
- **VBAT:** The VBAT connector in NuTiny-EVB-M453 to supply an extra battery power for RTC application. The default is shorted with VCC33.
- **VREF:** The VREF connector in NuTiny-EVB-M453 to supply an external reference voltage for analog peripherals. The default is shorted with VCC33.
- **VDDIO:** The VDDIO connector in NuTiny-EVB-M453 to supply a special voltage for some GPIOs. The default is shorted with VCC33.
- **JP1:** VCC5V connector in NuTiny-EVB-M453 to supply target chip voltage from an extra power supplier.
- **JP4:** GND connector in NuTiny-EVB-M453



2.2 Pin Assignment for Extended Connectors

The NuTiny-EVB-M453 provides the M453VG6AE target chip on board and the extended connectors (**JP5**, **JP6**, **JP7** and **JP8**) for LQFP 100-pin.

No	Pin Name	No	Pin Name
1	PB.13/EADC_CH10	24	PF.1/X32_IN
2	PB.14/EADC_CH11	25	PF.2/TAMPER
3	PB.15/EADC_CH12/TK2/ACMP0_P3/EBI_nCS1	26	PD.10/T2
4	PB.5/EADC_CH13/SPI0_MOSI0/SPI1_MOSI/TK3/ACMP0_P2/EBI_AD6	27	PD.11/T3
5	PB.6/EADC_CH14/SPI0_MISO0/SPI1_MISO/TK4/ACMP0_P1/EBI_AD5	28	PD.12/SPI2_SS/UART3_TXD/PWM1_CH0/EBI_ADR16
6	PB.7/EADC_CH15/SPI0_CLK/SPI1_CLK/TK5/ACMP0_P0/EBI_AD4	29	PD.13/SPI2_MOSI/UART3_RXD/PWM1_CH1/EBI_ADR17
7	nRESET	30	PD.14/SPI2_MISO/UART3_nCTS/PWM1_CH2/EBI_ADR18
8	PD.0/SPI1_I2SMCLK/UART0_RXD/TK6/ACMP1_N/INT3	31	PD.15/SPI2_CLK/UART3_nRTS/PWM1_CH3/EBI_ADR19
9	AV _{SS}	32	PD.7/PWM0_SYNC_IN/T1/ACMP0_O/PWM0_CH5/EBI_nRD
10	V _{DD}	33	PF.3/XT1_OUT/I2C1_SCL
11	V _{SS}	34	PF.4/XT1_IN/I2C1_SDA
12	PC.8/TK7	35	V _{SS}
13	PD.8/TK8/EBI_nCS0	36	V _{DD}
14	PD.9/TK9/ACMP1_P3/EBI_ALE	37	LDO_CAP
15	PD.1/PWM0_SYNC_IN/UART0_TXD/TK10/ACMP1_P2/T0/EBI_nRD	38	PC.9/SPI2_I2SMCLK/PWM1_CH0
16	PD.2/STADC/T0_EXT/TK11/ACMP1_P1/PWM0_BRAKE0/EBI_nWR/INT0	39	PC.10/SPI2_MOSI/PWM1_CH1
17	PD.3/T2/T1_EXT/TK12/ACMP1_P0/PWM0_BRAKE1/EBI_MCLK/INT1	40	PC.11/SPI2_MISO/PWM1_CH2
18	PD.4/SPI1_CLK/I2C0_SDA/TK13/PWM0_BRAKE0/T0	41	PC.12/SPI2_CLK/PWM1_CH3
19	PD.5/CLK0/SPI1_MISO/I2C0_SCL/TK14/PWM0_BRAKE1/T1	42	PC.13/SPI2_SS/PWM1_CH4
20	PE.3/SPI1_MOSI/TK15/PWM0_CH3	43	PC.14/PWM1_CH5
21	PD.6/CLK0/SPI1_SS/UART0_RXD/TK16/ACMP0_O/PWM0_CH5/EBI_nWR/	44	PC.0/SPI2_CLK/UART2_nCTS/CAN0_TXD/PWM0_CH0/EBI_AD8/INT2
22	V _{BAT}	45	PC.1/CLK0/STDAC/UART2_nRTS/CAN0_RXD/PWM0_CH1/EBI_AD9
23	PF.0/X32_OUT/INT5	46	PC.2/SPI2_SS/UART2_TXD/ACMP1_O/



			PWM0_CH2/EBI_AD10
47	PC.3/SPI2_MOSI/UART2_RXD/USB_VBUS_ST/ PWM0_CH3/EBI_AD11	73	USB_VBUS
48	PC.4/SPI2_MISO/I2C1_SCL/USB_VBUS_EN/ PWM0_CH4/EBI_AD12	74	USB_D-
49	PE.0/SPI2_CLK/I2C1_SDA/T2_EXT/SC0_CD/ PWM0_CH0/EBI_nCS1/INT4	75	USB_D+
50	PC.5/SPI2_I2SMCLK/PWM0_CH5/EBI_AD13	76	USB_ID
51	PC.6/I2C1_SMBAL/ACMP1_O/PWM1_CH0/ EBI_AD14	77	USB_VDD33_CAP
52	PC.7/I2C1_SMBSUS/PWM1_CH1/EBI_AD15	78	PE.2/PWM1_CH1
53	PE.4/I2C1_SCL/SC0_PWR/PWM1_BRAKE0/ EBI_nCS0/INT0	79	PA.3/USB_VBUS_ST/UART0_RXD/UART0_nRTS/ I2C0_SCL/SC0_PWR/PWM1_CH2/EBI_AD3
54	PE.5/I2C1_SDA/SC0_RST/PWM1_BRAKE1/ EBI_ALE/INT1	80	PA.2/USB_VBUS_EN/UART0_TXD/UART0_nCTS/ I2C0_SDA/SC0_RST/PWM1_CH3/EBI_AD2
55	PF.5/ICE_CLK	81	PA.1/UART1_nRTS/UART1_RXD/CAN0_TXD/ SC0_DAT/PWM1_CH4/EBI_AD1
56	PF.6/ICE_DAT	82	PA.0/UART1_nCTS/UART1_TXD/CAN0_RXD/ SC0_CLK/PWM1_CH5/EBI_AD0/INT0
57	PA.8/UART3_TXD	83	PA.12/SPI1_I2SMCLK/CAN0_TXD
58	PA.9/UART3_RXD	84	PA.13/CAN0_RXD
59	PA.7/SPI1_CLK/T0_EXT/EBI_AD7	85	PA.14/UART2_nCTS/I2C0_SMBAL
60	PA.6/SPI1_MISO/T1_EXT/EBI_AD6	86	PA.15/UART2_nRTS/I2C0_SMBSUS
61	PA.5/SPI1_MOSI/T2_EXT/EBI_AD5	87	V _{SS}
62	PA.4/SPI1_SS/EBI_AD4	88	V _{DD}
63	V _{SS}	89	AV _{DD}
64	V _{DD}	90	V _{REF}
65	PE.1/T3_EXT/SC0_CD/PWM0_CH1	91	PB.0/EADC_CH0/SPI0_MOSI1/UART2_RXD/ T2/DAC/EBI_nWRL/INT1
66	PE.8/UART1_TXD/SPI0_MISO1/I2C1_SCL/ SC0_PWR	92	PB.1/EADC_CH1/SPI0_MISO1/UART2_TXD/T3/ SC0_RST/PWM0_SYNC_OUT/EBI_nWRH
67	PE.9/UART1_RXD/SPI0_MOSI1/I2C1_SDA/ SC0_RST	93	PB.2/EADC_CH2/SPI0_CLK/SPI1_CLK/ UART1_RXD/SC0_CD
68	PE.10/SPI1_MISO/SPI0_MISO0/UART1_nCTS/ I2C0_SMBAL/SC0_DAT	94	PB.3/EADC_CH3/SPI0_MISO0/SPI1_MISO/ UART1_TXD
69	PE.11/SPI1_MOSI/SPI0_MOSI0/UART1_nRTS/ I2C0_SMBSUS/SC0_CLK	95	PB.4/EADC_CH4/SPI0_SS/SPI1_SS/ UART1_nCTS/ACMP0_N/EBI_AD7
70	PE.12/SPI1_SS/SPI0_SS/UART1_TXD/ I2C0_SCL	96	PB.8/EADC_CH5/UART1_nRTS/PWM0_CH2
71	PE.13/SPI1_CLK/SPI0_CLK/UART1_RXD/ I2C0_SDA	97	PB.9/EADC_CH6
72	V _{DDIO}	98	PB.10/EADC_CH7



99	PB.11/EADC_CH8/TK0	100	PB.12/EADC_CH9/TK1
----	--------------------	-----	--------------------

Table 2-1 M453VG6AE LQFP 100-pin Assignment for Extended Connectors

2.3 NuTiny-SDK-M453 PCB Placement

The following figure shows the NuTiny-SDK-M453 PCB placement.

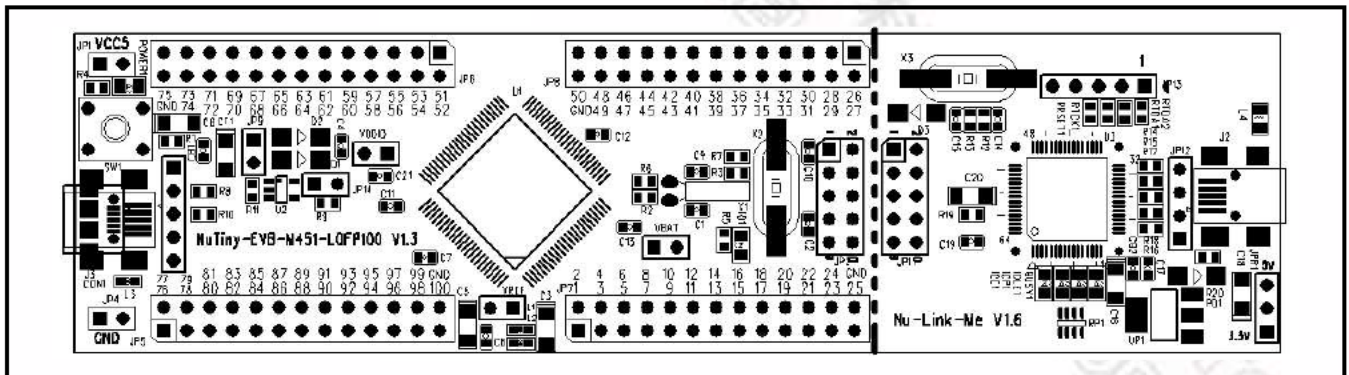

Figure 2-2 NuTiny-SDK-M453 PCB Placement

3 Starting to Use NuTiny-SDK-M453 on the Keil μ Vision[®] IDE

3.1 Downloading and Installing Keil μ Vision[®] IDE Software

Please connect to the Keil company website (<http://www.keil.com>) to download the Keil μ Vision[®] IDE and install the RVMDK.

3.2 Downloading and Installing Nuvoton Nu-Link Driver

Please connect to Nuvoton NuMicro[™] website (<http://www.nuvoton.com/NuMicro>) to download the “NuMicro[™] Keil μ Vision[®] IDE driver” file. Please refer to *section 6.1* for the detailed download flow. After the Nu-Link driver is downloaded, please unzip the file and execute the “Nu-Link_Keil_Driver.exe” to install the driver.

3.3 Hardware Setup

The hardware setup is shown in the following figure.



Figure 3-1 NuTiny-SDK-M453 Hardware Setup

3.4 Example Program

This example, as shown in the directory in Figure 3 2, demonstrates downloading and debugging an application on a NuTiny-SDK-M453 board. The example file can be downloaded from Nuvoton NuMicro™ website as described in section 6.3.

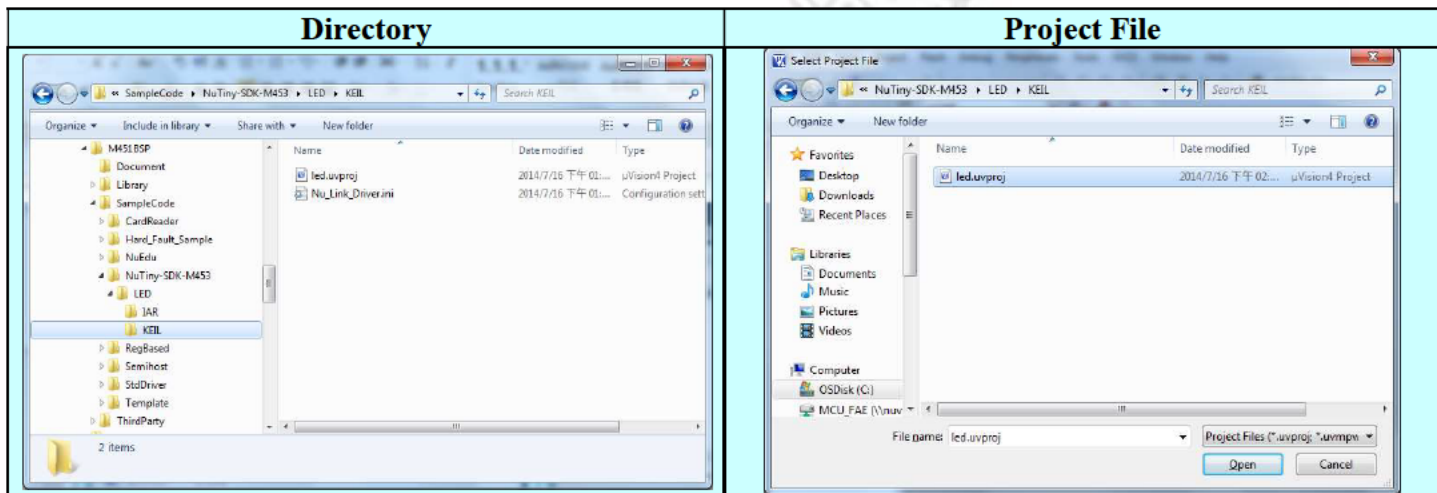









Figure 3-2 Example Directory

To use the example:

The I/O LED on the NuTiny-EVB-M453 board will be toggled on.

-  **Start μ Vision®**
- **Project – Open**
Open the led.uvproj project file
-  **Project – Build**
Compile and link the LED application
-  **Flash – Download**
Program the application code into on-chip Flash ROM
-  **Start Debug mode**
When using the debugger commands, you may:
 - ◆  Review variables in the watch window
 - ◆  Single step through code
 - ◆  Reset the device
 - ◆  Run the application

4 Starting to Use NuTiny-SDK-M453 on the IAR Embedded Workbench

4.1 Downloading and Installing IAR Embedded Workbench Software

Please connect to IAR company website (<http://www.iar.com>) to download the IAR Embedded Workbench and install the EWARM.

4.2 Downloading and Installing Nuvoton Nu-Link Driver

Please connect to Nuvoton Company NuMicro™ website (<http://www.nuvoton.com/NuMicro>) to download “NuMicro™ IAR EWARM Driver” file. Please refer to section 6.2 for the detail download flow. After the Nu-Link driver is downloaded, please unzip the file and execute the “Nu-Link_IAR_Driver.exe” to install the driver.

4.3 Hardware Setup

The hardware setup is shown in the following figure.



Figure 4-1 NuTiny- SDK-M453 Hardware Setup

4.4 Example Program

This example, as shown in the directory in Figure 4-2, demonstrates downloading and debugging an application on a NuTiny-SDK-M453 board. The example file can be downloaded from Nuvoton NuMicro™ website as described in *section 6.3*.

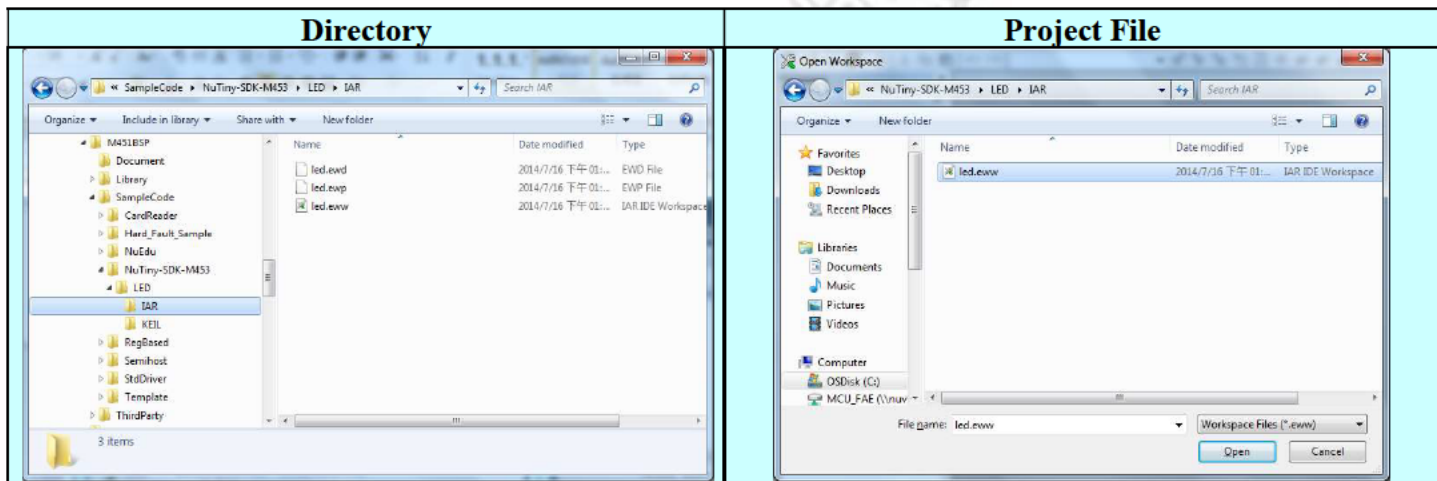

Figure 4-2 Example Directory

To use the example:

The I/O LED on the NuTiny-EVB-M453 board will be toggled on.

- **Start IAR Embedded Workbench**
- **File-Open-Workspace**
Open the led.eww workspace file
- **Project - Make**
Compile and link the LED application
- **Project – Download and Debug**
Program the application code into on-chip Flash ROM
 - ◆ Single step through code
 - ◆ Reset the device
 - ◆ Run the application



5 NuTiny-SDK-M453 Schematics

5.1 NuTiny-EVB-M453 Schematic

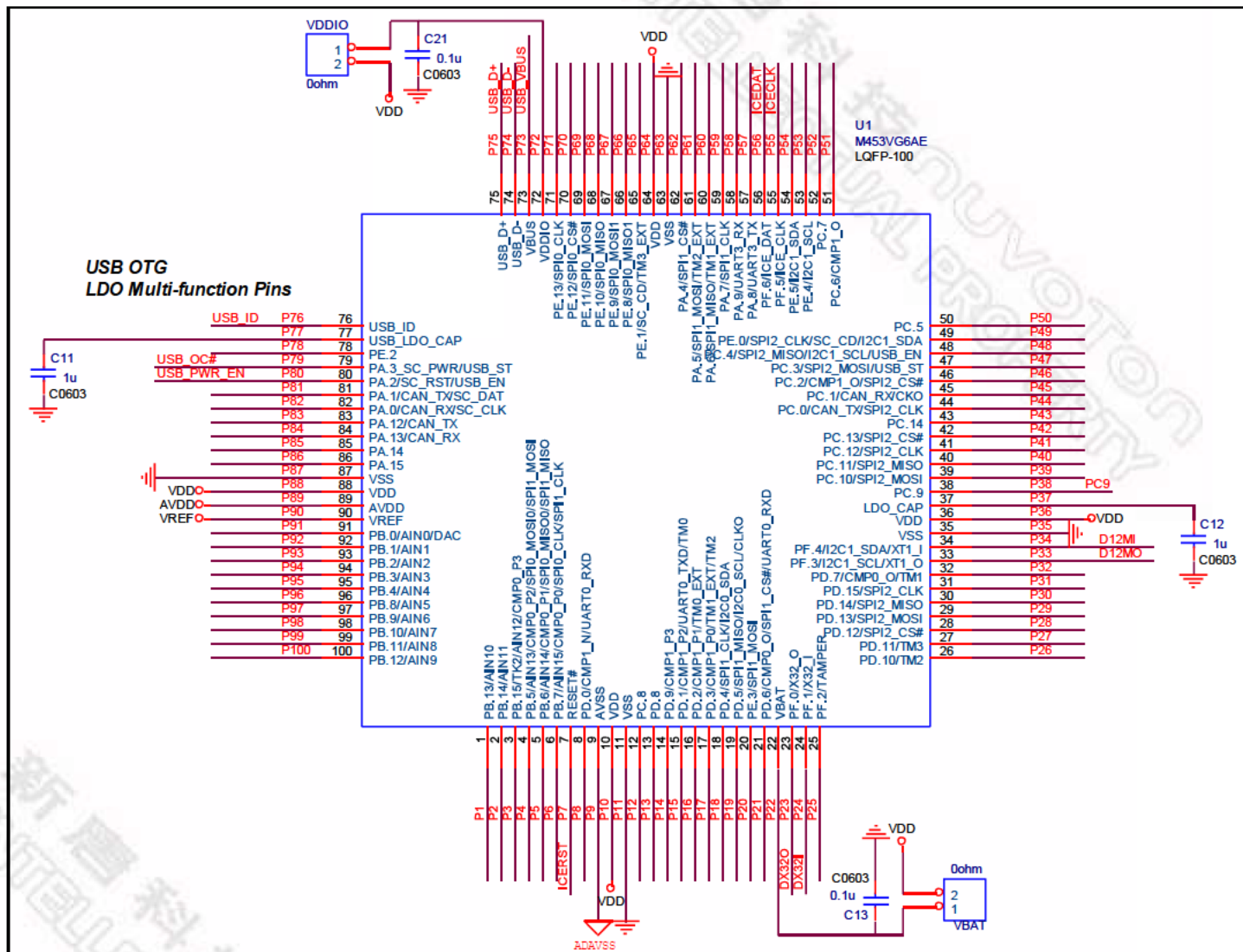

Crystal

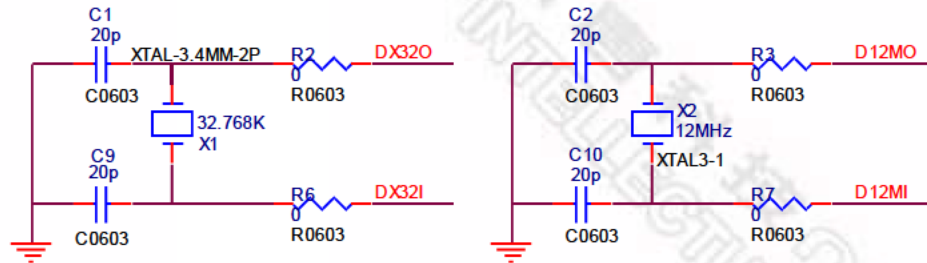

Reset

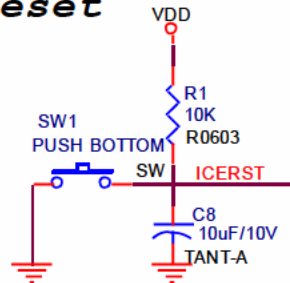

USB Host/Device

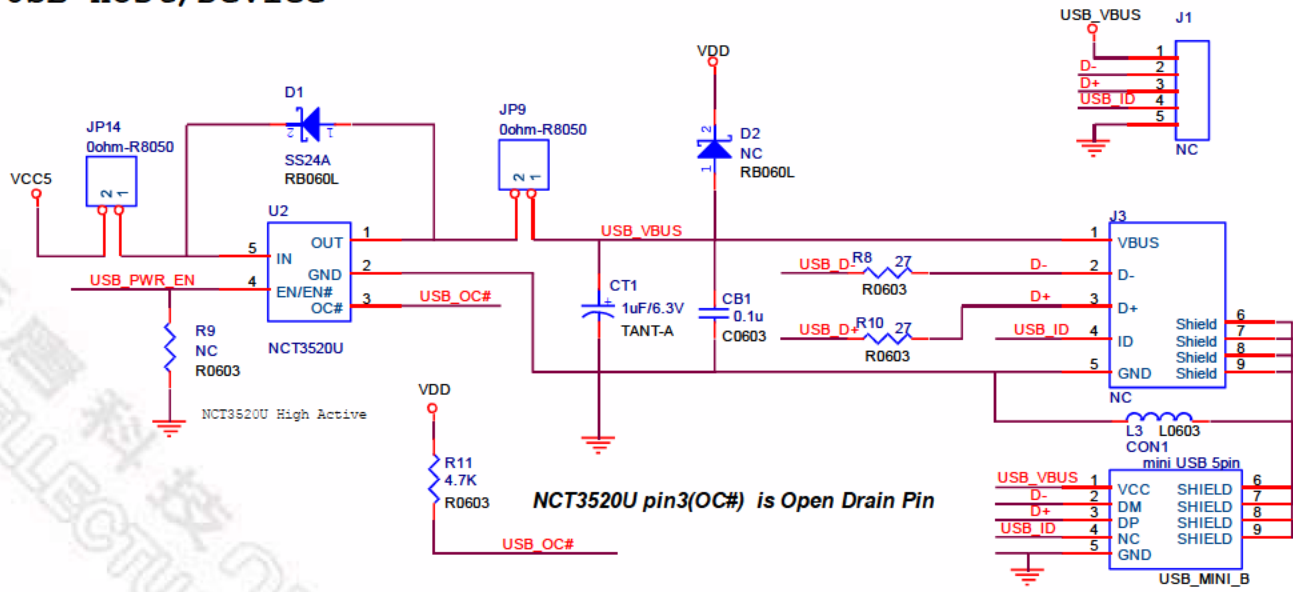

Power

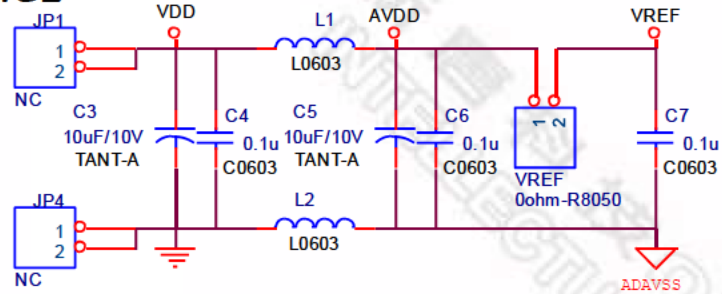

Connector

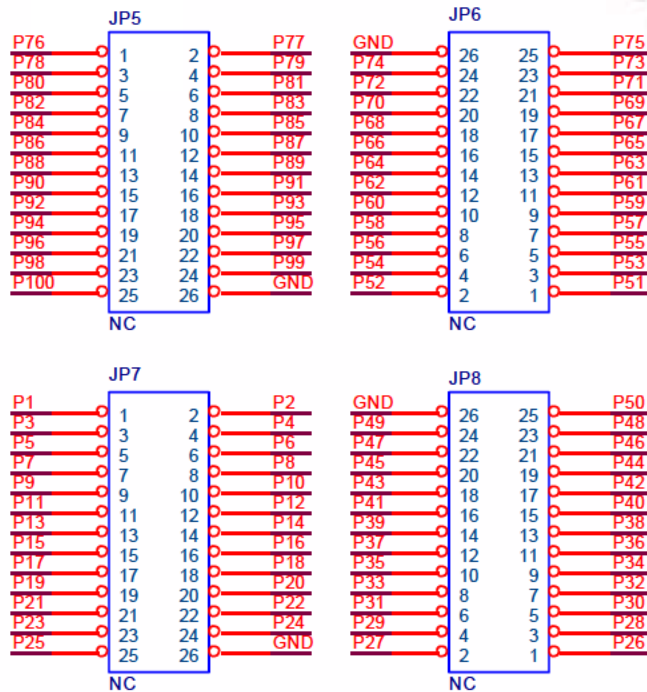

Debug Interface & Off Page

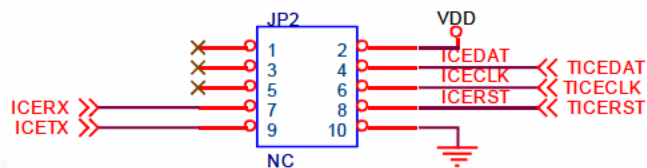

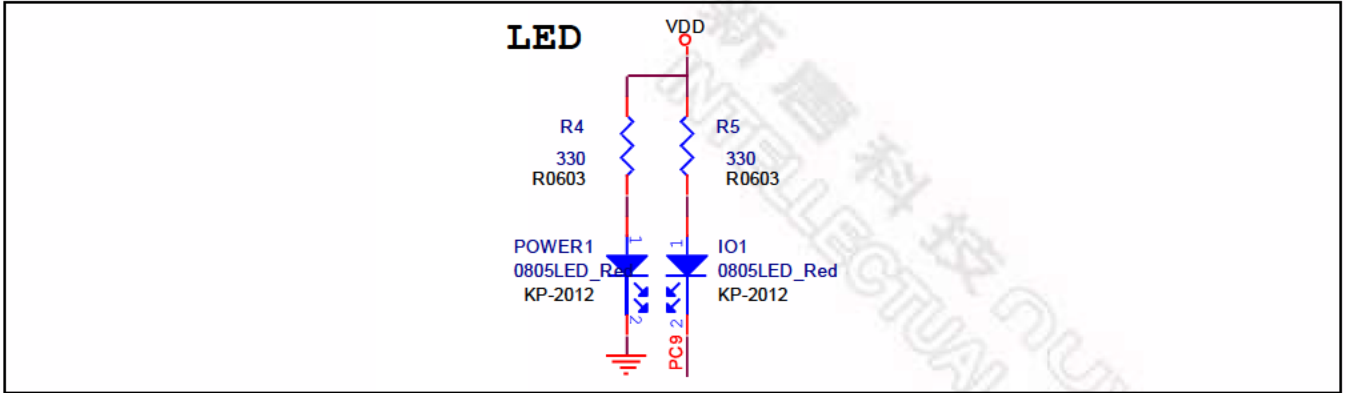

5.2 Nu-Link-Me Schematic

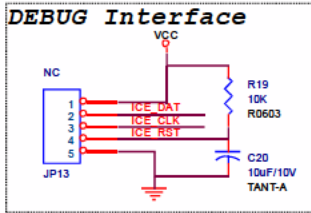
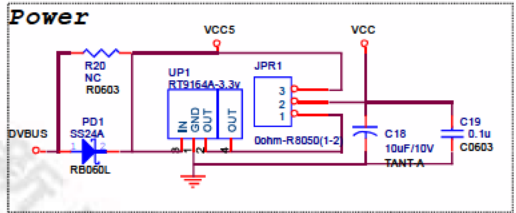
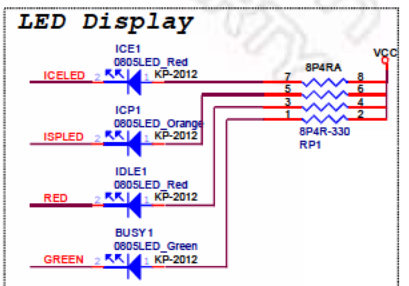
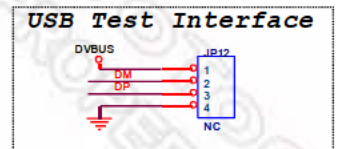
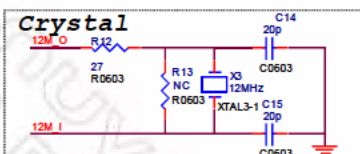
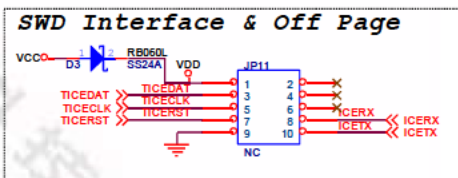
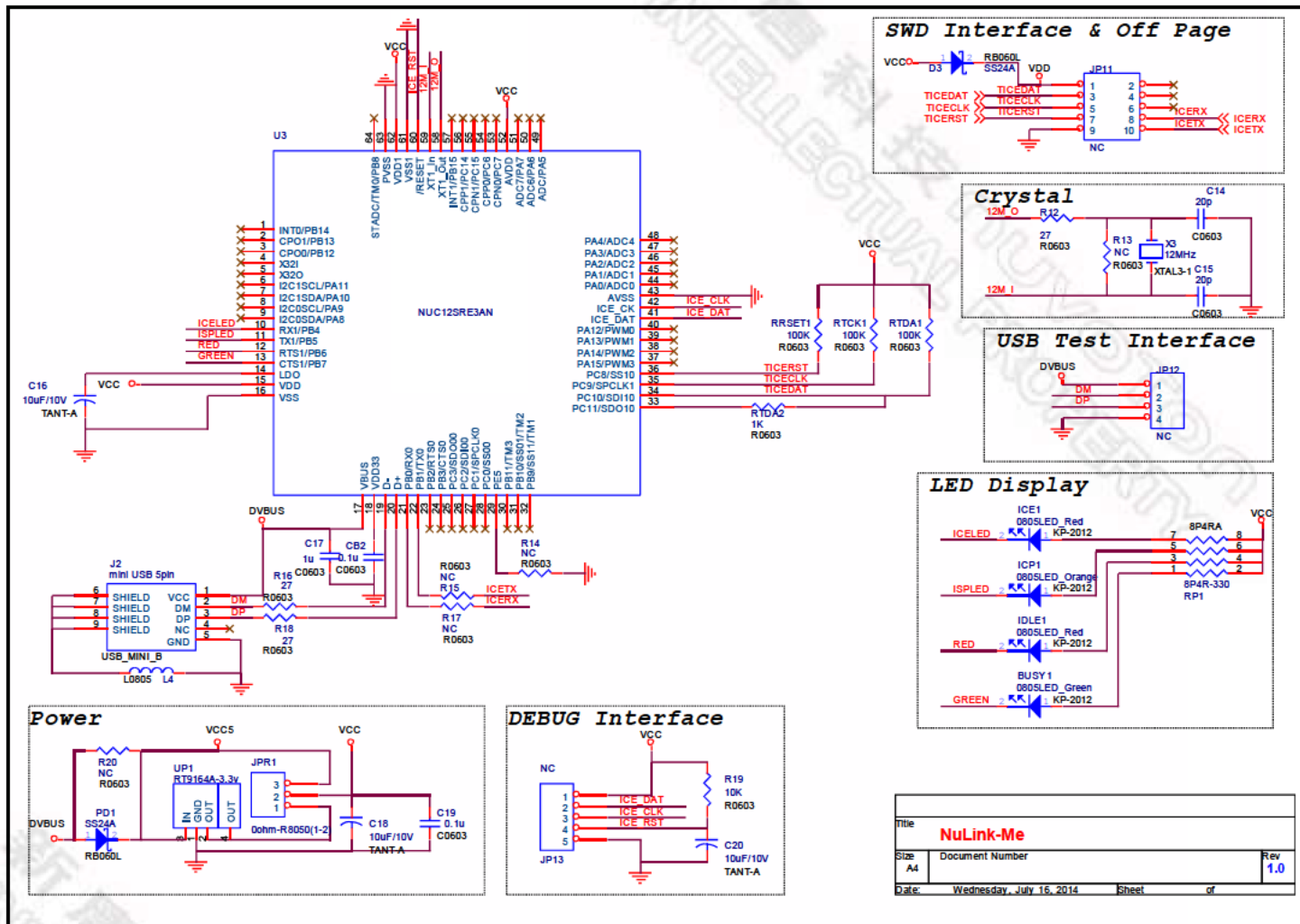

Title		
NuLink-Me		
Size	Document Number	Rev
A4		1.0
Date:	Wednesday, July 16, 2014	Sheet of



6 Downloading NuMicro™ Related Files from Nuvoton Website

6.1 Downloading NuMicro™ Keil μVision® IDE Driver

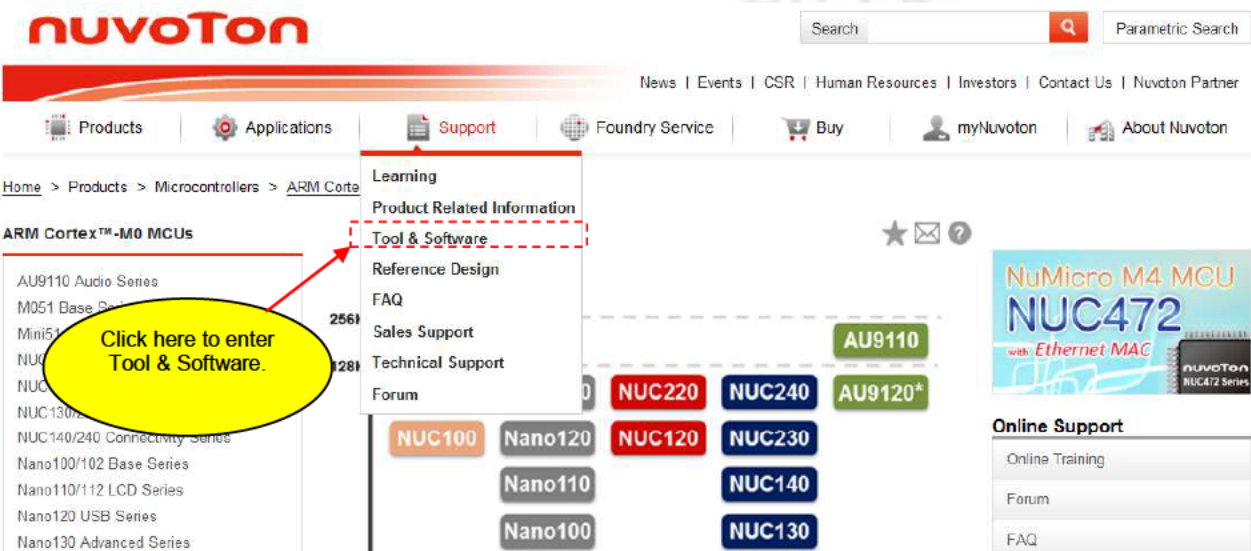
Step1	Visit the Nuvoton NuMicro™ website: http://www.nuvoton.com/NuMicro
Step2	
Step3	

Step4

Programmer Software Tools Package

File name	Description	Version	Date
ICP Programming Tool V1.25.6287.zip Revision History	NuMicro ICP tool & user manual	V1.25.6287	2014-01-16
ISP Programming Tool V1.44.zip Revision History	NuMicro ISP Programming Tool & user manual	V1.44	2014-01-20
NuGang Programmer V6.21.zip Revision History	NuGang Programmer software & user manual	V6.21	2014-01-24

Nu-Link Driver

File name	Description	Version	Date
Nu-Link Driver for Keil RVMDK V1.25.6287.zip Revision History	This driver is to support Nu-Link to work under Keil RVMDK Development Environment for all NuMicro Family Devices.	V1.25.6287	2014-01-16
Nu-Link Driver for IAR EWARM V1.25.6287.zip Revision History	This driver is to support Nu-Link to work under IAR EWARM Development Environment for all NuMicro Family Devices.	V1.25.6287	2014-01-16

User Feedback ↑ TOP

Step5 Download the NuMicro™ Keil μVision® IDE driver.

Click here to download the file.

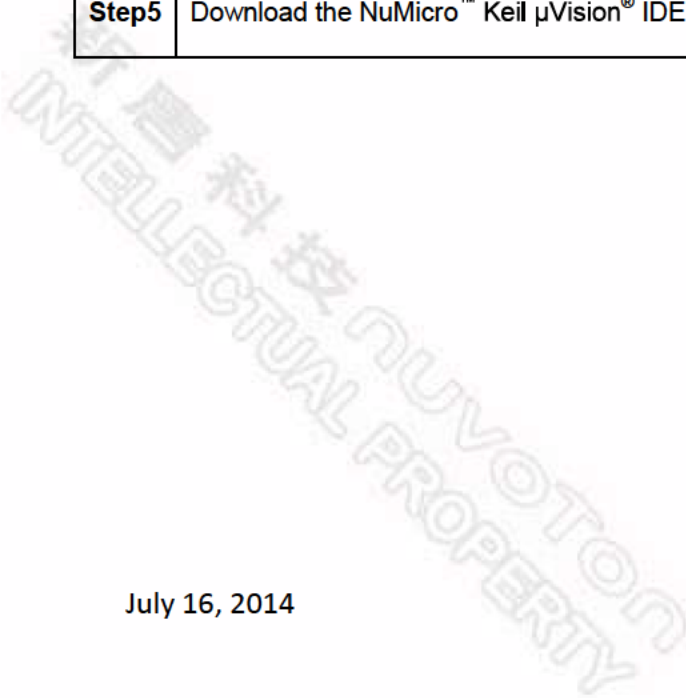



6.2 Downloading NuMicro™ IAR EWARM Driver

Step1 Visit the Nuvoton NuMicro™ website: <http://www.nuvoton.com/NuMicro>.

Step2

Step3

Step4

Programmer Software Tools Package

File name	Description	Version	Date
ICP Programming Tool V1.25.6287.zip Revision History	NuMicro ICP tool & user manual	V1.25.6287	2014-01-16
ISP Programming Tool V1.44.zip Revision History	NuMicro ISP Programming Tool & user manual	V1.44	2014-01-20
NuGang Programmer V6.21.zip Revision History	NuGang Programmer software & user manual	V6.21	2014-01-24

Nu-Link Driver

File name	Description	Version	Date
Nu-Link Driver for Keil RVMDK V1.25.6287.zip Revision History	This driver is to support Nu-Link to work under Keil RVMDK Development Environment for all NuMicro Family Devices.	V1.25.6287	2014-01-16
Nu-Link Driver for IAR EWARM V1.25.6287.zip Revision History	This driver is to support Nu-Link to work under IAR EWARM Development Environment for all NuMicro Family Devices.	V1.25.6287	2014-01-16



Click here to download the file.

User Feedback ↑ TOP

Step5 Download the NuMicro™ IAR EWARM driver.

新唐科技 NUVOTON
INTELLECTUAL PROPERTY

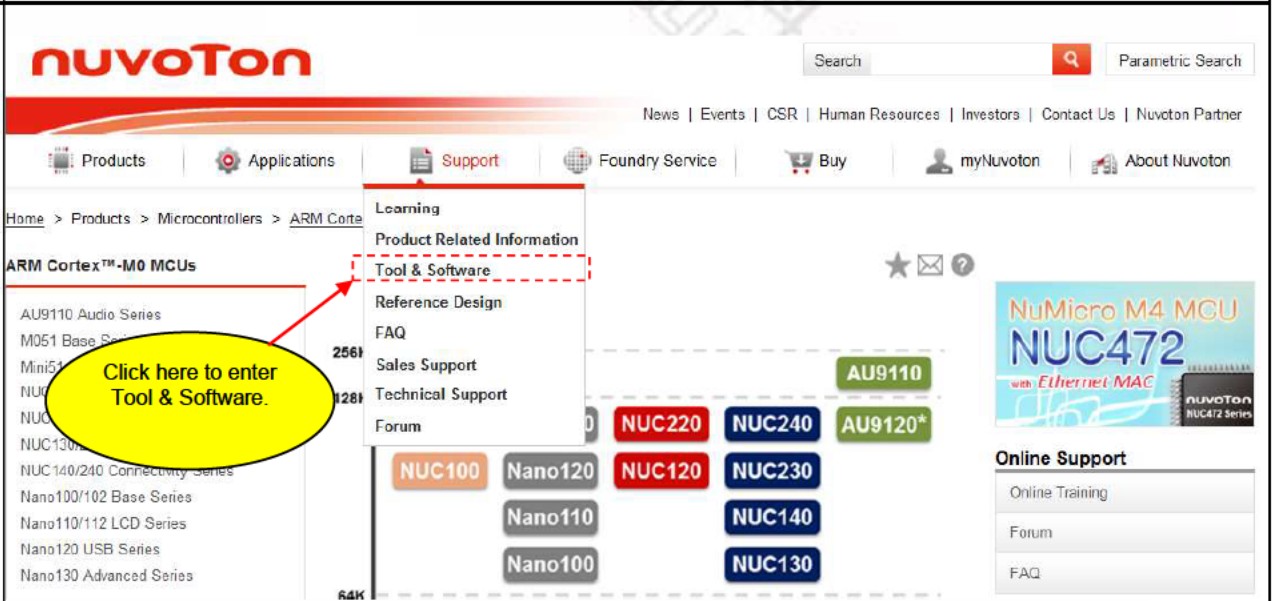
6.3 Downloading NuMicro™ M453 Series BSP Software Library

<p>Step1</p>	<p>Visit the Nuvoton NuMicro™ website: http://www.nuvoton.com/NuMicro.</p>
<p>Step2</p>	
<p>Step3</p>	
<p>Step 3</p>	<p>Download the NuMicro™ M453 Series CMSIS BSP.</p>

7 Revision History

Revision	Date	Description
1.0	July 16, 2014	Initial release

Important Notice

Nuvoton Products are neither intended nor warranted for usage in systems or equipment, any malfunction or failure of which may cause loss of human life, bodily injury or severe property damage. Such applications are deemed, "Insecure Usage".

Insecure usage includes, but is not limited to: equipment for surgical implementation, atomic energy control instruments, airplane or spaceship instruments, the control or operation of dynamic, brake or safety systems designed for vehicular use, traffic signal instruments, all types of safety devices, and other applications intended to support or sustain life.

All Insecure Usage shall be made at customer's risk, and in the event that third parties lay claims to Nuvoton as a result of customer's Insecure Usage, customer shall indemnify the damages and liabilities thus incurred by Nuvoton.

Please note that all data and specifications are subject to change without notice.
All the trademarks of products and companies mentioned in this datasheet belong to their respective owners.